

Open Frame Touch Monitor

HO 165 PGB

39,6 cm / 15.6" Diagonal
LED Backlight – Format 16:9

- 1920 x 1080 Resolution Full HD 1080P
- 10-Point Touch P-Cap Technology
- High Brightness 500 cd/m² Panel
- 178° / 178° Ultra-Wide Viewing Angle
- Triple Input: HDMI + DP + VGA
- **IP65 Rating Level**
- **Display Protection: Thickness 7.3mm**
- **Built for 24/7**
- **50.000 Hours Backlight Lifetime**
- **Built-in Speakers**
- Operating Temperature: -10~60°C
- Sturdy Metal Case
- VESA Mount and Multiple Mounting Options
- Edge to Edge glass without raised frame
- Orientation: Landscape, Portrait, Face-Up

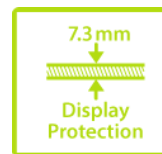
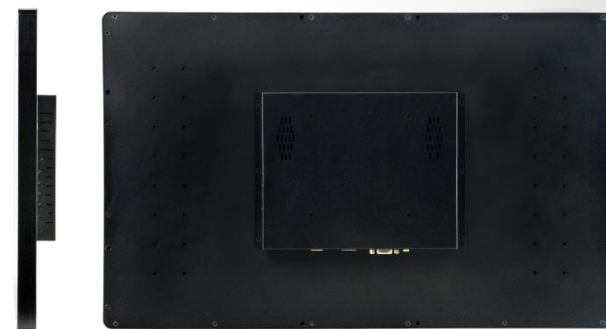

39,6 cm / 15.6"

Part. No.: HO 165 PGB

SIZE, RESOLUTION



15.6"
16:9 Aspect Ratio



Full HD
1920 x 1080

CONNECTIVITY, IP LEVEL



VGA
HDMI
Display Port



IP 65
Water & Dust
Protection

VIEWING ANGLE, VESA

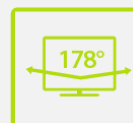

178° Ultra-Wide
Viewing Angle



VESA
Wall-Mountable

OTHER FEATURES



Operating
24 Hours / 7 Days



50.000 Hours
Lifetime

Display Size	39,6 cm / 15.6" Diagonal
Panel Type	TFT – LED Backlight, IPS Panel Type
Aspect Ratio	16:9
Resolution (H x V)	1920 x 1080 Full HD
Brightness	500 cd/m ² (Panel) – 425 cd/m ² (Monitor)
Contrast (Typ.)	1000:1 (Typical) – 10M:1 (Active Contrast)
Display Area	345,23 x 194,54 mm
Viewing Angle L/R; U/D	178° H / 178° V (CR > 10)
Response Time	25 msec
Pixel Pitch	0,17925 (H) X 0,17925 (V) mm
Touch Type	Projected Capacitive Type – 10 Point Touch Material Glass + Glass Cover Glass+LOCA+ITO (Indium Tin Oxide) Glass
Display Colors	16.2M Colors
Horizontal Frequency	31.5 ~ 80 kHz
Vertical Frequency	60 ~ 75 Hz
Max Display Frequency	1920 x 1080 @ 60Hz
Input 1	VGA
Input 2	HDMI
Input 3 / 4	Display Port / USB for Touch
Speakers	Yes, 1,5W x 2
Power Consumption	On: 12,7W; Stand-by: 0,3W; Off: 0,2W
AC Power Range	External Power Supply: 12 Volt / 2,5A Input: AC 100 ~ 240 Volt; 50 ~ 60 Hz
Product Dimensions	387,3 x 44,3 x 236,4 mm (W x D x H)
Packing Dimensions	464 x 100 x 325 mm (W x D x H)
Net / Gross Weight	3,4 Kg / 4,7 Kg

VESA Mounting	100x100mm. Screws: M4, 10mm(Max), pitch 0,7 mm
Display Protection	TP Module Protection Thickness 7,3mm
Hardness / Transmittance	≥6H Toughened hard panel surface / ≥85%
IP Rating Level	IP 65 (Front), Water and Dust Protection *
Control	Menu/Exit,Bri (+),Vol (-) , Input/Enter,Power
LED Backlight life	50.000 hours
On Screen Display	8 Languages
Color	9300, 6500, 5300, User Mode
Preset Mode	Standard, Text, Movie, Game Modes
Operating Temperature	-10°~60°C
Orientation	Landscape, Portrait, Face-Up
Accessory	Power Adaptor; EU and UK Power Cables (1,5mt); HDMI Cable (1,5mt); USB 2.0 (B-A) Cable for Touch (1,8mt).

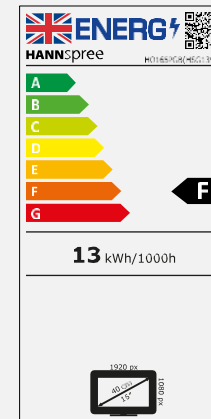
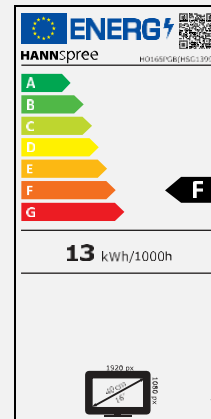

Supplier's Name	HANNspree
Model Name	HO165PGB
Energy efficiency class for standard Dynamic Range (SDR)	F
Annual Energy Power Consumption (kWh/1000h)	13 kWh/1000h
On mode power demand for Standard Dynamic Range (SDR)	12,7 W
Off mode power demand (W)	0,2 W
Standby mode power demand (W)	0,3 W
Screen Diagonal (cm / inches)	39,6cm / 15.6"
Resolution	1920 x 1080

PART. NO.:
HO 165 PGB



4 711404 023040 >

HANNSpree

HO 165 PGB
15.6" Open Frame Touch Monitor

Experts in **Display**



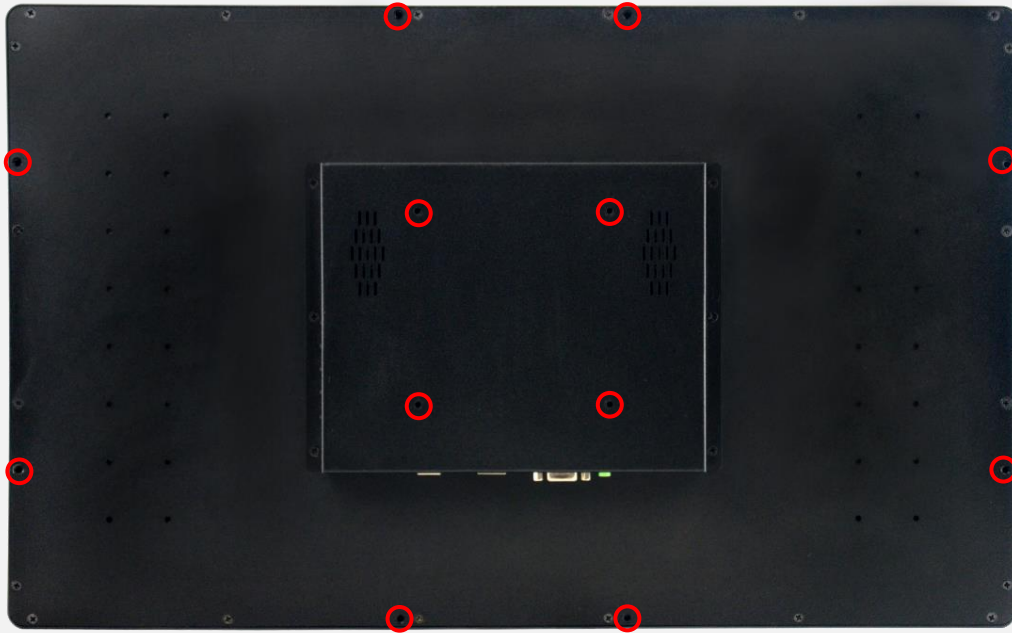

Front Cover :

Full Flat Design

Screws: M4 x 10mm (max), pitch 0.7, UNC type

HANNSpree

HO 165 PGB
15.6" Open Frame Touch Monitor

Experts in **Display**



HO 165 PGB 15.6" Open Frame Touch Monitor

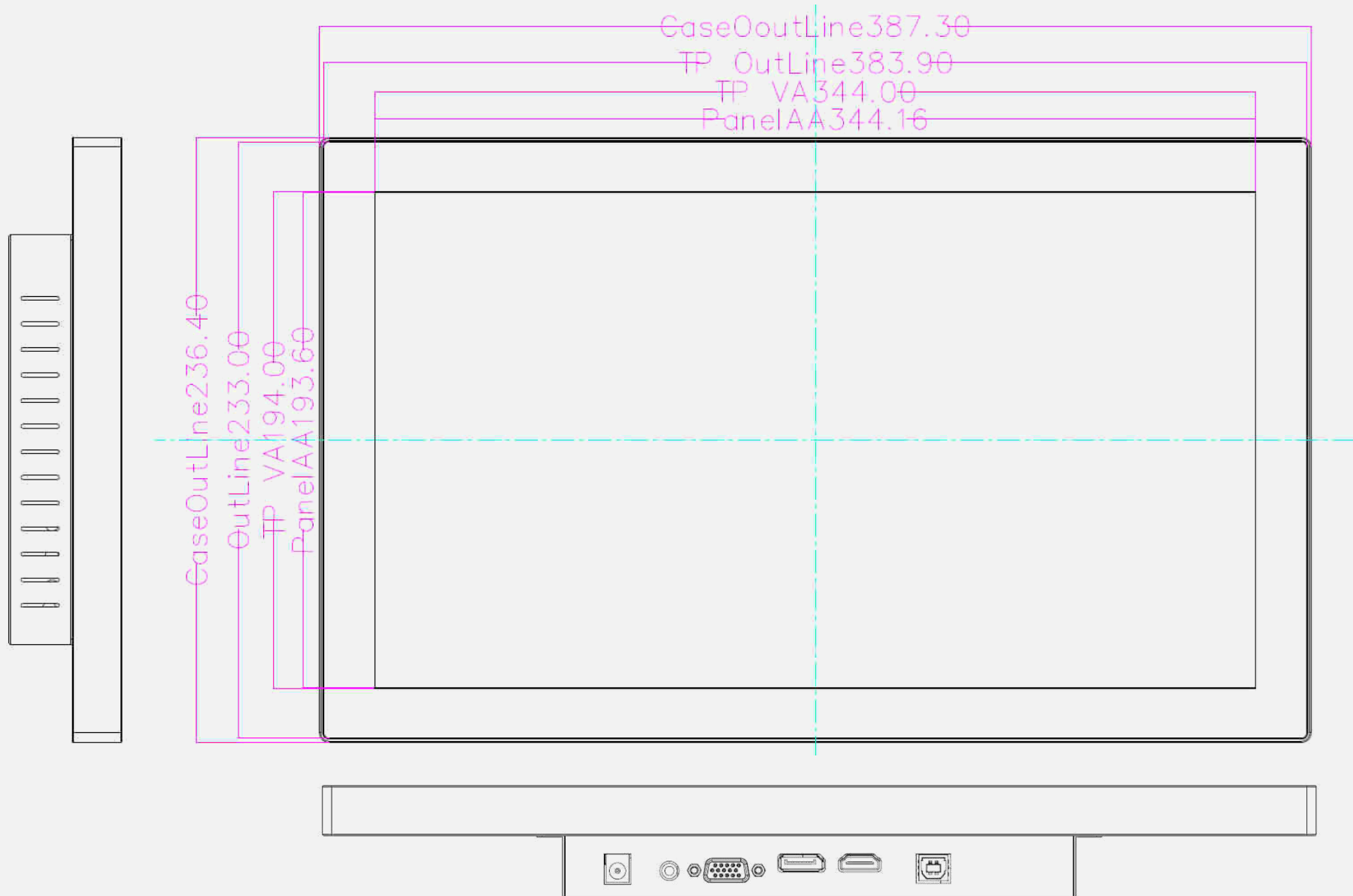

HO 165 PGB 15.6" Open Frame Touch Monitor

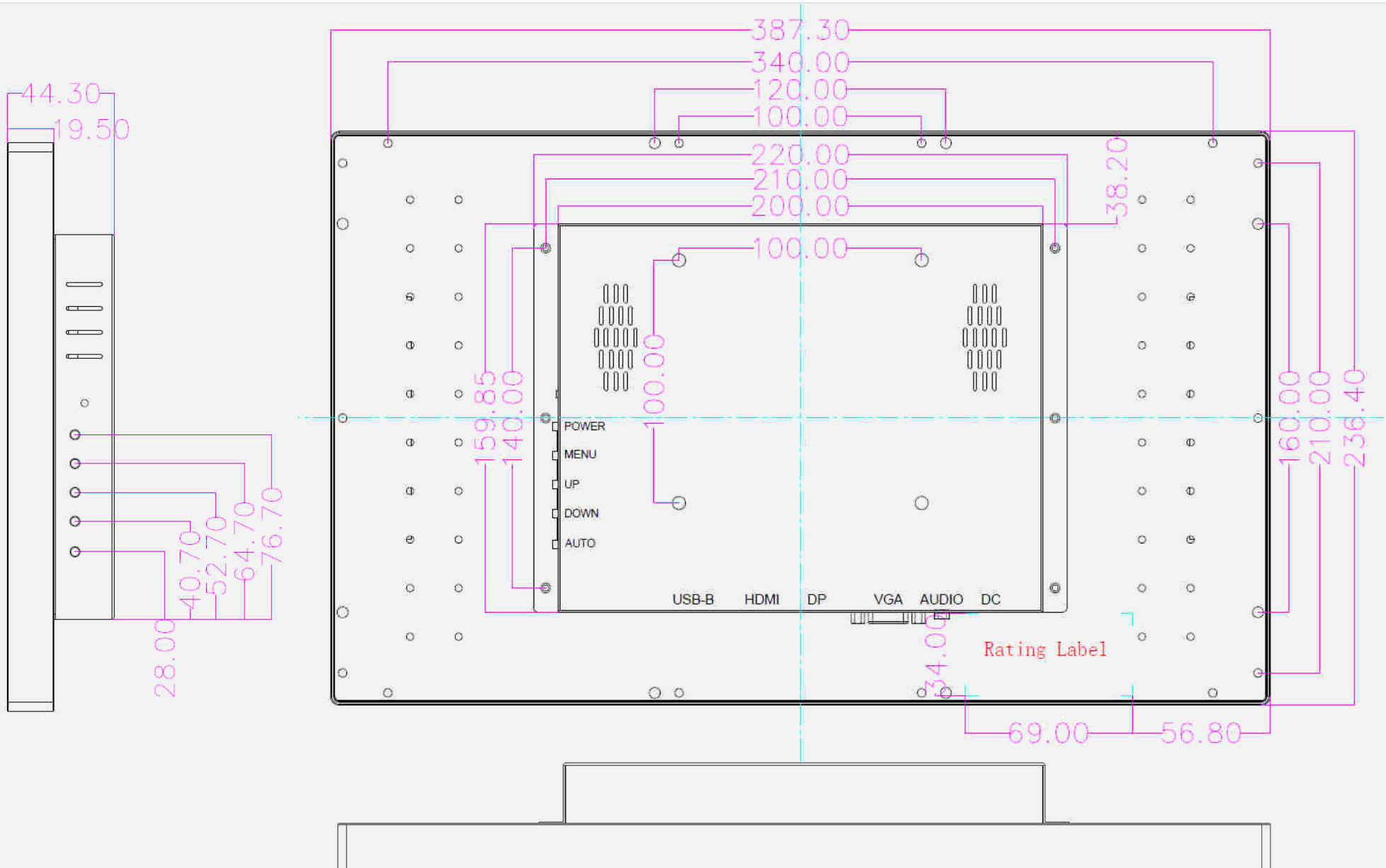

HANNspree

HO 165 PGB
15.6" Open Frame Touch Monitor

Experts in **Display**

